



Color CCD Camera

WAT-221S2

Operation Manual

This Operation Manual covers safety, camera functions, installation and the correct operating procedure for the WAT-221S2. First, we ask you to read this Operation Manual thoroughly, then install and operate the WAT-221S2 as advised. In addition, for future reference, we also advise safekeeping of this manual.

Please contact the distributor or dealer from which the WAT-221S2 was purchased, if you do not understand the installation, operation or safety instructions laid out in this manual. Not understanding the contents of the Operation Manual sufficiently may cause damage to the camera.

Guide to the Safety Symbols

The definitions of the symbols used in this operation manual are:



When you do not adhere to or take notice of the "Danger" sign, it may lead to a serious accident such as death or injury caused by fire or electric shock.



When you do not adhere to or take notice of the "Warning" sign, it may cause severe damage such as a physical injury.



When you do not adhere to or take notice of the "Caution" sign, it may incur injury and cause damage to peripheral objects in the immediate surroundings.

Cautions for Safety

The WAT-221S2 is designed to be used safely; however, if not used safely, it may lead to a physical accident caused by fire and electric shock. Therefore, please keep and read the "Cautions for safety" below for protection against accidents.



- Do not disassemble and/or modify the WAT-221S2.
- Do not operate the WAT-221S2 with wet hands.



- Use a stabilized power adaptor designed for DC+12V±10%, with a current capacity of more than 250mA for the WAT-221S2. The recommended voltage is DC+12V±10%.
- Do not expose the WAT-221S2 to wetness or high moisture conditions. The WAT-221S2 is designed and approved for indoor use only. The WAT-221S2 is not water-resistant or waterproof. If the location of the camera is outdoors or in an outdoor like environment, we recommend that you use an outdoor camera housing.
- Protect the WAT-221S2 from condensation. Keep the WAT-221S2 dry at all times during storage and operation.
- Should the camera not work properly, switch off the power immediately. Then check the camera according to the "Problems and Trouble shooting" section.



- Avoid the striking of hard objects or dropping the WAT-221S2. The WAT-221S2 uses high quality electrical parts and precision components.
- Do not connect any power supply directly to the video out terminal of the unit. Do not connect the WAT-221S2 with any monitor using a video/power single transmission terminal. The WAT-221S2 is not designed for use with this type of equipment. We also advise you to read the operation manual of the monitor you plan to use before any connections are made.
- Do not install the WAT-221S2 in a position subject to direct sunlight. Sunlight shining directly onto the WAT-221S2 lens can cause damage to the CCD.
- Select a stable place for installation of the WAT-221S2. Use a support of durable strength around an installation position on a ceiling or wall when a camera stand or tripod is used.
- Do not move the WAT-221S2 with the cables connected. Before moving the WAT-221S2, always remove the video cable and power cable from the rear of the camera first.
- Avoid using the WAT-221S2 near any strong electro-magnetic field. After installing into main equipment, if the WAT-221S2 is exposed to electromagnetic waves causing the monitored image to become distorted, we recommend the camera be shielded by appropriate protective casing.

Problems and Trouble Shooting

If any of the following problems occur when using the WAT-221S2,

- An optimal picture cannot be obtained, after checking that all the cables and connections are correctly in place
- Smoke or any unusual odor emerges from the WAT-221S2
- An object becomes embedded or a quantity of liquid seeps into the camera housing
- More than the recommended voltage or/and amperage has been applied to the WAT-221S2 by mistake
- Anything unusual occurring to any equipment connected to the WAT-221S2

Disconnect the camera immediately according to the following procedures:

- Switch off the main power supply to the camera.
- Remove the power and video cables connected to the WAT-221S2.
- Contact the distributor or dealer from which the WAT-221S2 was purchased.

About EMC

The WAT-221S2 is in conformity with EMC test standards carried out by authorized organizations in Japan.

NTSC FCC Part15 class B
P A L EN61000-6-3/EN50130-4

※Please use an auxiliary power supply (eg: UPS) to this camera to comply with EN50130-4 of EMC standards.



Do not modify the WAT-221S2. A modified camera may not conform to EMC test standards.

Contents

Using the contents figures below, check to make sure all parts are present before use.

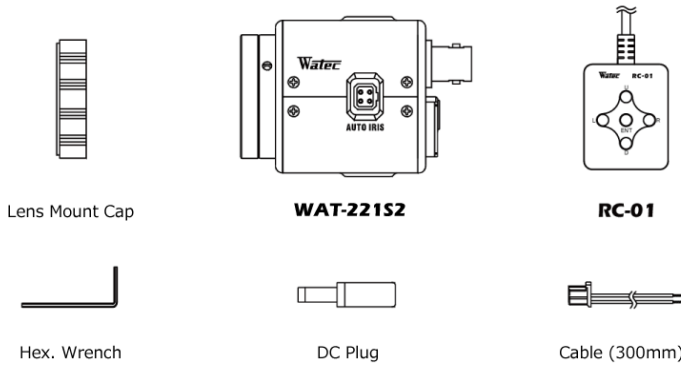

Description of Parts

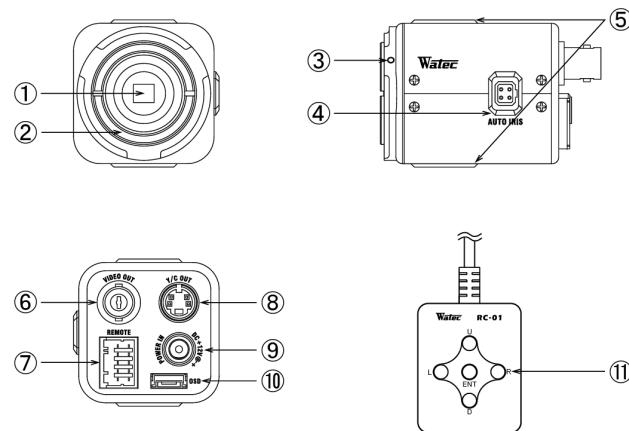

①IMAGE SENSOR FRONT FACE

- The light receiving face of the image sensor (Dirt, water or oil deposits on the image sensor will cause an unclear picture on the monitor. Attach the lens cap to protect the lens and the CCD from contamination and damage.)

②LENS MOUNT

- Mount for the lens (CS-mount)

③FINE FOCUS ADJUSTMENT SCREWS

- There are 3 hex. adjustment screws each placed at intervals of 120° for fine focusing of the lens.

④AUTO-IRIS SOCKET

- This socket is for the video/DC auto-iris lens cable connector. (Video/DC: Auto selected by the camera)

⑤TRIPOD MOUNTING SCREW HOLES

- Mounting holes for stands. The size of these threads are 1/4", 20 threads, 4.5 ±0.2mm, which is the same as any standard camera tripod (U1/4").

⑥VIDEO OUT (BNC)

- The terminal for composite video signal output

⑦I/O CONNECTOR

- The control terminal for the RS-485 and ALARM.

⑧Y/C OUT

- The terminal for Y/C signal output.

⑨POWER IN

- The terminal designed for connection with the DC-plug of the power adaptor.

⑩OSD(On Screen Display) CONNECTOR

- The terminal designed for connection with the remote control for setting the functions on the screen.

⑪OPERATION BUTTON

- The operation button for setting the functions on the screen.

Power Supply

Use a stabilized power adaptor designed for DC+12V±10%, with a current capacity of more than 250mA.

Use the optional DC plug if the shape or polarity of the DC plug of the power adaptor to be used is not compatible with the camera (See the drawing on the right below).

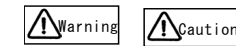

The wiring of the connector must be exact. Be careful not to touch the other terminal while wiring. Protect the wiring portion by using insulation tape after wiring. If the above care and attention is not adhered to, damage to the WAT-221S2 and power adaptor may occur and may also cause fire.

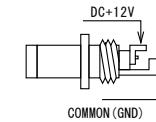

Auto-iris Lens

Before connecting the auto-iris lens, please make sure that the pin configuration is correct by confirming with the following table. If the configuration of your iris connector is different from the following, the plug and pins will need to be rewired.

Pin No.	EIAJ Video Auto-iris Lens Arrangement	EIAJ DC Auto-iris Lens Arrangement
①	Power	Control -
②	Not used	Control +
③	Iris signals	Drive +
④	Common (GND)	Drive -

Mechanical Back

Mechanical Back(M.B) is the projection from the lens mount to the camera. Use a lens with a mechanical back that is less than 5.0mm to the WAT-221S2.

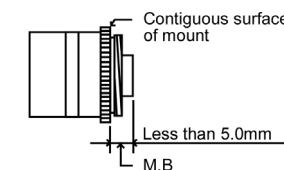

Set-up and Operation

- Ensure that the power to the WAT-221S2 and the peripheral equipment is turned off before making any connections.
- Remove the lens mount cap from the WAT-221S2 and attach the CS-mount lens. Use the optional C-mount adaptor (34CMA-R) when a C-mount lens is used.
- Connect the iris control cable to ④AUTO-IRIS SOCKET on the WAT-221S2 when an auto-iris lens is being used.
- Connect ⑥VIDEO OUT on the WAT-221S2 with the monitor, using a coaxial cable with 75 impedance, such as an RG-59 or an RG-6/U. If the monitor has an S-terminal, high resolution imaging is possible by connecting with ⑧Y/C OUT.
 - ※The ⑧Y/C OUT can be used together with the ⑥VIDEO OUT.
 - ※Select a monitor with the same television system as the WAT-221S2 NTSC or PAL. A monitor with more than 600TV lines is recommended.
- Insert the power plug of the power adaptor into ⑨POWER IN on the back panel of the WAT-221S2. Confirm that the power adaptor is not connected to the power supply before insertion of the power plug into ⑨POWER IN.
- Turn on the power to the WAT-221S2, monitor and all other allied equipment. When a picture cannot be obtained on the monitor, or a problem occurs, check and follow the procedure mentioned in the 【Problems and Trouble Shooting】 section.
- After following the procedure below and the picture is still out of focus, open the iris fully and loosen ③FINE FOCUS ADJUSTMENT SCREWS with the hex. wrench and move the lens forwards until a clear picture is obtained.

Manual Lens	Adjust the focus and iris to the best position on the lens.
Video Auto-iris Lens	Adjust the focus on the lens/camera, then adjust the focus on the lens. .
DC Auto-iris Lens	Adjust the iris level on the camera, then adjust the focus on the lens.

※When using a DC Auto-Iris lens, adjustments to the iris level can be done by changing the level in the OSD menu by use of the remote control (RC-01) included.

- When detailed settings are required or an adequate image is not obtained, connect the remote control(RC-01) to ⑩ OSD(On Screen Display) CONNECTOR, then set the functions on the screen by ⑪OPERATION BUTTON.
- When controlling the RS-485 and alarm output, connect to ⑦I/O CONNECTOR after wiring using the attached cable. See the pin configuration as follows.

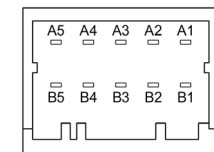

(Camera side)

PIN No.	Cable color	Title	Function	
A1	-	NC	-	
B1	-	NC		
A2	-	NC	-	
B2	-	NC		
A3	Orange	ALARM (1)	Motion detection alarm out (Photo MOS relay output, Nonpolar)	
B3	Orange/ White	ALARM (2)		
A4	-	NC	-	
B4	Black	GND		Camera GND
A5	Gray	RXD (+)	RS-485 (non-isolated)	Data input from the camera side
B5	Gray/ White	RXD (-)		Data input from the camera side

Alarm output terminal

When the motion detection function is selected, the alarm output terminals, A3 and B3, are closed circuit by detecting any movement in the monitored area. If an alarm is attached as the diagram indicated below, the alerting system (sound, light, etc.) turns on by the closed circuit. Please make sure that the attached alarm supply voltage is 16V or less between the 2 terminals and the output current 250mA or less.

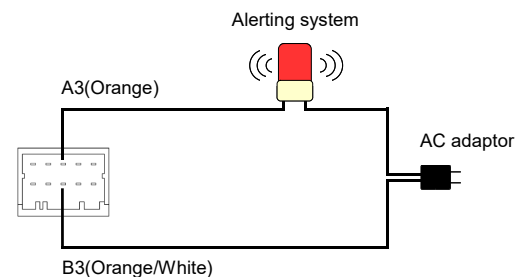

※When connecting to the induced load(relay, motor) or incandescent electric lamp, take measures against surge voltage and inrushing current on the outside circuit.

RS485 Communication

OSD operation is possible through the use of the RS485 communication line and a PC or Pelco-D protocol compatible DVR, Controller, etc... (refer to diagram below).

The voltage levels between the input terminals A5(RXD[+]) and B5(RXD[-]) must be between -7 to +12V. Please take caution to connect the input terminals with the correct polarity. Please refer to the user's manual for the RS485 compatible equipment for proper connection and use.

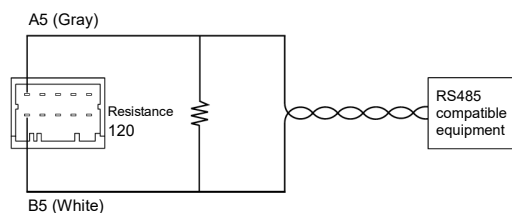

※The Camera does not have a termination resistor, therefore, as needed, please terminate the connection on the cable side (Termination Resistor 120Ohms)

Contact information

- Design and specifications are subject to change without notice.
- Watec is not responsible for any inconvenience or the attendant damages to the video and monitoring recording equipment caused by misuse, mis-operation or improper wiring of our equipment.
- If for any reason the WAT-221S2 does not work properly, or if you have any questions regarding installation or operation, please contact the distributor or dealer from which it was purchased.

Contact information

Watec Watec Co., Ltd.

Add.: 254-2 Nihonkoku, Daihoji, Tsuruoka- Shi,
Yamagata-Ken, 997-0017 Japan
TEL: +81-235-23-4400 FAX: +81-235-23-4409
Email: info-o@watec.co.jp
URL: <http://www.watec.co.jp>

1592Z00-Y2200004

Options

To purchase these options, please contact the distributor or dealer from which you purchased the WAT-221S2.



C-mount Adaptor (34CMA-R)

This lens mount adaptor is used to convert a CS-mount to a C-mount.



Mini Stand (MS50)

A convenient stand for the WAT-221S2. With this stand, the camera can be adjusted to any desired angle.